



**PARK
FURNITURE
AUSTRALIA**

PFA113
Fort Lytton



The Fort Lytton picnic setting range is made from our own ECOPLASWOOD product, which is a recycled plastic material manufactured to look like wood but designed to last a lot longer. Ecoplaswood will not rot, warp, fade, craze or split. This product is impervious to insects, salt water, hot and cold weather extremes and it is graffiti proof.

Available in 3 standard sizes. the Fort Lytton range is suitable for public spaces where long lasting picnic settings are placed.



Strong &
Durable



Will not rot
or discolour



Eco
Sustainable



Maintenance
Free



Termite
Resistant



Technical Specifications

PFA113
Fort Lytton

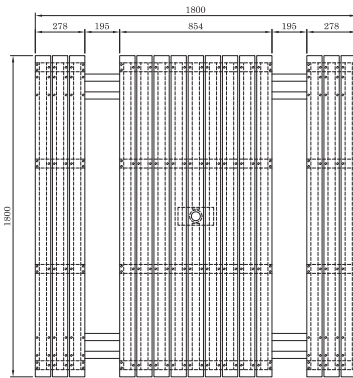

TOP VIEW

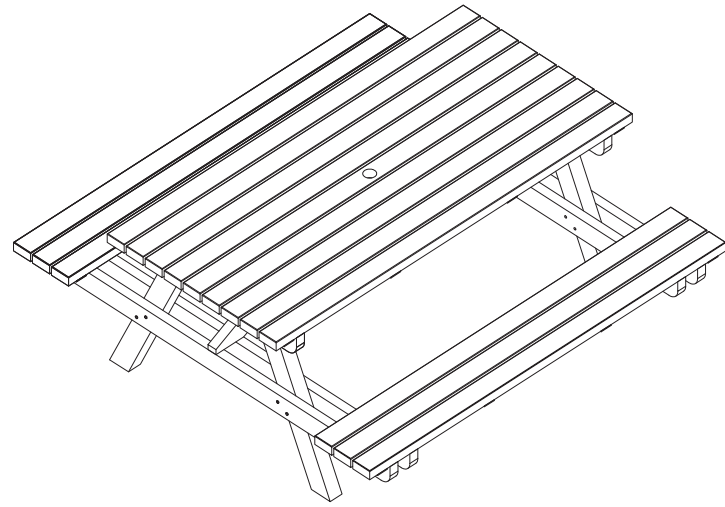
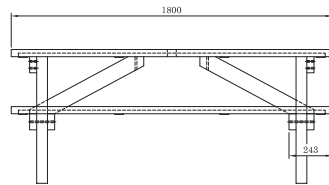
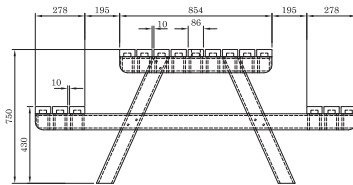

Dimensions

1800L x 1800W x 750H

Materials

Ecoplaswood recycled plastic frame
Ecoplaswood recycled plastic battens
Galvanised steel supports and brackets

Fixings

Bolt down | Freestanding

Finishes

Recycled plastic colours
Galvanised brackets

Other options

Custom modifications

Lengths available

1800 | 2000 | 2400 | custom

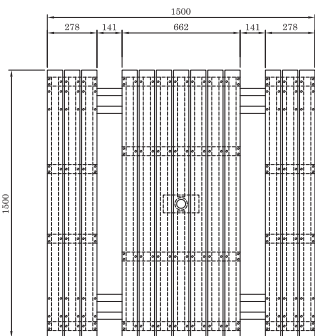

TOP VIEW

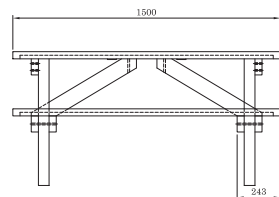
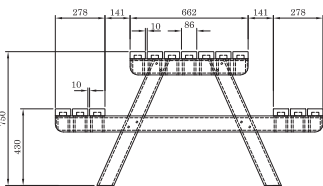

Ecoplaswood colours

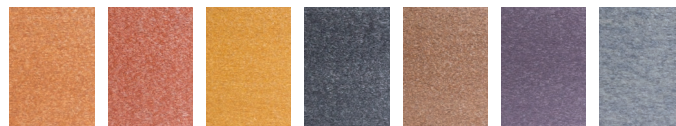

Park Furniture Australia are proud to actively work towards meeting these sustainable development goals as laid out by the United Nations.

